



AUTOMODELLE 1:87

KOLLEKTION 2020

INKL. SOMMER- UND WINTER-NEUHEITEN





WARUM EIGENTLICH EIN BUSCH-MODELL?

Liebe Sammler, liebe Modellbauer,

es ist schön, ein besonderes Hobby zu haben, ein Hobby, das überschaubar und vor allen Dingen bezahlbar bleibt. Busch-Automodelle erscheinen jedes Jahr in verschiedenen Varianten und in überschaubaren Stückzahlen, die den Modellmarkt nicht überschwemmen und Sie als Sammler nicht überfordern sollen. So bleibt es stets möglich, einen Modelltyp oder eine spezielle Sparte problemlos zu sammeln. Das Sammeln von Automodelnen ist darüber hinaus längst keine alleinige Männerdomäne mehr, auch viele Frauen sind hinter den kleinen detailverliebten Kunststoff-Flitzern her. Die Smart-Aera dürfte wohl hier das Eis gebrochen haben. Vielleicht sind es aber auch die Vielfalt und das kreative Design der 1:87er Miniaturen, die sich aus der breiten Masse herausheben. Ein Farb-Wechsel innerhalb eines Modelltyps ist nicht gerade spektakulär, die Details und Veränderungen machen es aus. Ausgefallene Bedruckungen, Beladungen und Gestaltungen machen aus bestehenden Modellformen plötzlich ein ganz anderes Fahrzeug. Die Realität gibt so viele Vorlagen, die wir immer wieder gerne einsetzen, um für Sie daraus ein Kunstwerk zu schaffen - Kunstwerke als Teil

einer einzigartigen Sammlung oder als besonderer Blickfang auf Modellbahnanlagen, Dioramen und Schaustücken eines im Detail arbeitenden Modellbauers.

Auch wenn ein spezielles Vorbild momentan durch seine vielen Besonderheiten als Modell nicht umsetzbar ist, wir probieren immer und immer wieder. So entwickeln wir spezielle Techniken, die uns eines Tages zum Erfolg führen und gleichzeitig neue Wege erschließen – ein weiterer Schritt in die Entwicklung ist getan. Wir legen nicht nur unseren eigenen Maßstab immer höher, Sie als Sammler oder Modellbauer profitieren auch davon und erhalten eine immer bessere und höhere Qualität. Vielleicht ist es Ihnen auch schon aufgefallen, unsere Drucke werden immer feiner und dünner, die Modelle immer detailreicher und spektakulärer – Kunstwerke in miniature »Made in Germany«.

Mit freundlichen Grüßen
Ihr Busch-Team

VORSCHLÄGE ?

Haben Sie zu Hause oder im Urlaub ein tolles Auto entdeckt, das als Druck- oder Formenneuheit interessant ist? Dann schnell ein Foto von allen vier Seiten des Fahrzeugs gemacht und zusammen mit den Infos ins Kuvert und ab an:
Busch Automodelle,
Postfach 12 60, D-68502 Viernheim

FARBSORTIERUNG

Fast alle Fahrzeuge werden in mindestens zwei Farben sortiert geliefert. Über die aktuellen Farben und Farbänderungen informiert Sie gerne Ihr Fachhändler. Farbabweichungen und Farbänderungen gegenüber dem Katalog behalten wir uns vor.

ERSATZTEILSERVICE

Ist ein kleines Teil verloren gegangen oder wurde etwas beschädigt? Kein Problem, gegen Einsendung von € 4,00 in Briefmarken können Sie diese Teile bei uns anfordern. Die Lieferung von Umrüstsätzen ist jedoch nicht möglich!

NEUHEITEN-LIEFERTERMINNE

NEU ab September 2020 lieferbar

NEU Herbstneuheiten ab Oktober 2020 lieferbar

Weitere Infos über das Busch Automodelle-Sortiment: www.busch-model.com

Busch-Automodelle werden aus Kunststoff hergestellt. Abgebildete Neuheiten sind teilweise Prototypen. Farb-, Ausführungs- und Materialänderungen bei allen Modellen vorbehalten.

Audi-Modelle: Marken-, Geschmacksmuster- und Urheberrechte werden benutzt mit der Erlaubnis des Inhabers Audi AG. Mercedes-Benz-Modelle: Marken-, Geschmacksmuster- und Urheberrechte werden benutzt mit der Erlaubnis des Inhabers Daimler AG/Mercedes-Benz Accessories GmbH. Smart-Modelle: Marken-, Geschmacksmuster- und Urheberrechte werden benutzt mit der Erlaubnis des Inhabers Daimler AG/Smart GmbH.

VW KÄFER MIT BREZEL- UND OVALFENSTER

Er läuft und läuft und läuft... Seit über 60 Jahren rollt der Käfer auf allen Straßen der Welt. Mittlerweile ist die alte Busch-Modellform in die Jahre gekommen. Fortschritt und Technik sind nicht stehen geblieben, eine neue Form ist von Nöten!



FORMNEUHEIT
52900 mit Brezelfenster
Grün, Bj. 1952



FORMNEUHEIT
52901 mit Brezelfenster
Rot, Bj. 1952



FORMNEUHEIT
52902 mit Brezelfenster
Schwarz, Bj. 1952



FORMNEUHEIT
52950 mit Ovalfenster
Blau, Bj. 1955



FORMNEUHEIT
52951 mit Ovalfenster
Grau, Bj. 1955



FORMNEUHEIT
52952 mit Ovalfenster
Grün, Bj. 1955

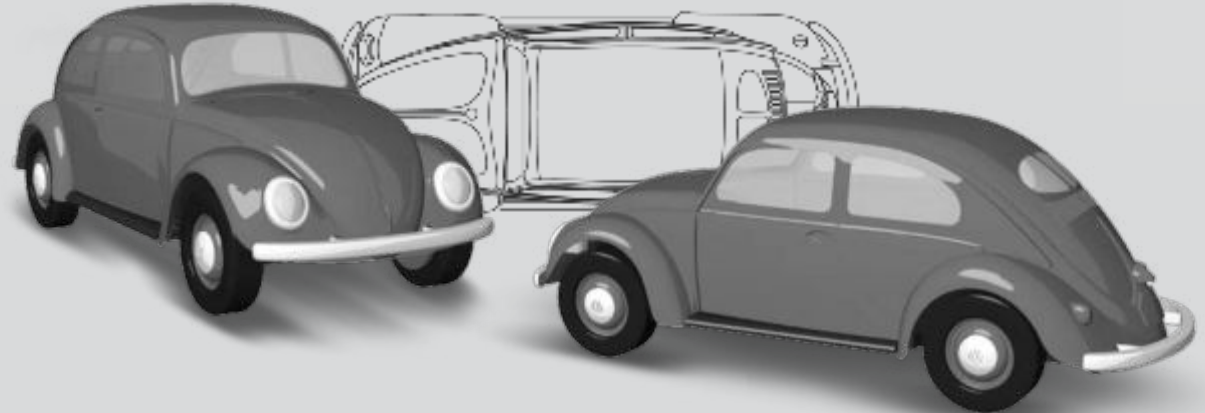
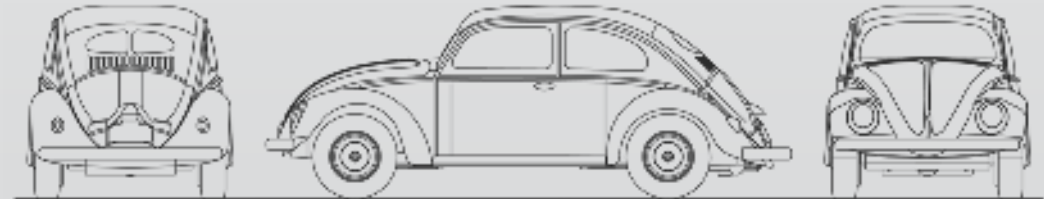



40006 Benz-Patent-Motorwagen
Bj. 1886
Lieferung in PC-Box



59917 Daimler-Reitwagen
mit Figur, Bj. 1885
Lieferung in PC-Box



40007 Benz-Patent-Motorwagen
mit Bertha Benz, Bj. 1886
Lieferung in PC-Box



59916 Benz-Patent-Motorwagen
Victoria, Bj. 1893
Lieferung in PC-Box



59918 Daimler-Lastwagen
Bj. 1896
Lieferung in PC-Box



9838899 BMW Dixi
sortiert



99 87010 Austro-Daimler 18/32
Bj. 1914



99 87015



41327 Horch 853
Bj. 1933



41315 Horch 853
Scheunenfund, Bj. 1933



41334
Cabrio offen



41316
mit Gepäckkoffer



41204 Ford Eifel
Bj. 1929



46714 VW Hebmüller
offen, Bj. 1949



46718 VW Hebmüller
offen, Bj. 1949



46732



46733



46735
Metallica



42710 VW Käfer
mit Brezlfenster, Bj. 1949



42720 VW Käfer
mit Ovalfenster, Bj. 1951



42734 VW Käfer
mit Dachgepäckträger, Bj. 1951



40510 Mercedes-Benz 170S
Bj. 1949



9838323 Jaguar XKSS
sortiert, Baujahr 1956



48810 Messerschmitt Kabinenroller KR 200
Deluxe, Bj. 1956



51704 Nagetusch
Bj. 1958



51702



44450 Bentley
Bj. 1959



44451
Bj. 1959



46524 Renault 4 CV
Bj. 1958



46525



43129 Borgward Isabella Coupé
Metallica, Bj. 1958



43173



45801 Karmann Ghia 1600
Bj. 1961



45808



45816



9838120 Jaguar E-Type
sortiert, Bj. 1961



48727 Fiat 500
on Tour, Bj. 1965



48705 Fiat 500
Bj. 1965



48724



48411 NSU 1000 TT
Bj. 1965



48412



48413



47117 Morgan Plus 8
Metallica, Bj. 1968



47145



47151
Bizzarro



43031 Toyota Land Cruiser J4
Bj. 1960



43032



43033



48002 Citroën DS 19
Frankreich mit gelben Scheinwerfern, Bj. 1955



46519 Renault 4 CV
Frankreich mit gelben Scheinwerfern, Bj. 1958



46871 Mercedes-Benz W123
Frankreich mit gelben Scheinwerfern, Bj. 1977



47152 Morgan Plus 8
mit Gepäckbrücke und Koffer, Bj. 1968



48802 Messerschmitt Kabinenroller KR 200
mit Gepäckträger und Koffer, Bj. 1956



45901 MG Midget TC
Cabrio offen mit Gepäckbrücke und Koffer, Bj. 1968



50374 Land Rover Defender
mit Dachzelt, Bj. 1983



50556 Lada 1600
mit schwarzem Dach, Orange, Bj. 1976



48028 Citroën DS 19
Bj. 1955



48020



48026



52700 VW 181 Kurierwagen
Baujahr 1970



52701



52702



44960 Tabbert-Wohnwagen
Baujahr 1971



46841 Mercedes-Benz W123 T-Modell
Bj. 1977



46844



46858 Mercedes-Benz W123
Unverwüstlich, Bj. 1977



46864
mit Gepäckträger



46865 Mercedes-Benz W123
mit Schlitten und Bob, Bj. 1977



42110 Opel Kadett C
2-farbig Orange, Bj. 1977



47414 Ford Probe 24V
Metallica, Bj. 1994



50703 Smart Fortwo Coupé 2014
CMD-Collection Bj 2014



50300 Land Rover Defender
Bj. 1983



50301 Land Rover Defender
Bj. 1983



50302



50352 Land Rover Defender
Metallica, Bj. 1983



50353



50360 Land Rover Defender
Lion, Bj. 1983



51449 Puch G-Modell, Bj. 1990



51401 Mercedes-Benz G-Klasse
Bj. 1990



51402



51900 Land Rover Discovery
Baujahr 1998



51901



51902



51930 Land Rover Discovery
Bj. 1998



51931



51932



51464 Mercedes-Benz G-Klasse 08
Tuning, Bj. 2008



50663 Mercedes-Benz Citan Kombi
mit Wildkorb und Reh, Bj. 2012



Ansiicht
von hinten!



AMERIKANISCHE PKW & CRAZY CARS

American vehicles · Véhicules américains



44511 Amerikanischer Bus „Fishbowl“ mit Schilderausstattung, Bj. 1959

44512



44513 Amerikanischer Bus „Fishbowl“ mit Schilderausstattung, Bj. 1959

44518



44500 Amerikanischer Bus „Fishbowl“ Grün, Bj. 1959



47602 Chevrolet Caprice Monster-Truck, Mud Patrol, Bj. 1994

Lieferung in PC-Box



44721 Buick '50 Deluxe, Bj. 1950

44722



43421 Cadillac '52 Bj. 1952

45425



45411 Chevrolet Corvette Bj. 1956

45428 Metallica



45038 Chevrolet Bel Air '57 Cabrio geschlossen, Bj. 1957

45046 Metallica



44982 Airstream Wohnwagen, Bj. 1958



47575 Ford Mustang Coupé Muscle-Car, Bj. 1964



44623 Plymouth Voyager Woody, Bj. 1990

44624

ZIRKUSFAHRZEUGE

Circus vehicles · Véhicules de cirque



51213 Framo V901/2 Zirkus Busch, Bj. 1954



51214 Framo V901/2 Zirkus Olympia, Bj. 1954



51278 Framo V901/2 Zirkus Aeros, Bj. 1954



51756 Nagetusch Zirkus Busch, Bj. 1972



51816 Robur Garant K 30 Kastenwagen Zirkus Aeros, Bj. 1957



46184 Smart Fortwo, Facelift Roncalli, Bj. 2007

NEU



41930 Citroën H Roncalli, Bj. 1958

NEU

BLACK EDITION

Black Edition · Black Edition



46872 Mercedes-Benz W123 Limousine, Black Edition, Bj. 1977



50929 Mercedes-Benz Unimog U 430 Black Edition, Bj. 2013



44212 Mercedes-Benz E-Klasse Limousine, Black Edition, Bj. 2009



43607 Mercedes-Benz C-Klasse Limousine, Black Edition, Bj. 2007



51469 Mercedes-Benz G-Klasse Black Edition, Bj. 2008

NEU



51173 Mercedes-Benz V-Klasse Black Edition, Bj. 2014

NEU

BESTATTUNGSFAHRZEUGE

Hearses · Corbillards



42920 Cadillac 70 Station Wagon Bestattungsfahrzeug, Bj. 1970



52203 Mercedes-Benz VF 123 Miesen Bestattungswagen, Bj. 1977



51130 Mercedes-Benz Vito Bestattungsfahrzeug, Bj. 2014



51131 Mercedes-Benz Vito Bestattungsfahrzeug, Bj. 2014



42923 Cadillac 70 Station Wagon Bestattungsfahrzeug Skull, Bj. 1970

NEU



42924 Bestattungsfahrzeug Braunmetallic

NEU



52100 UAZ 469
Bereitschaftspolizei, Bj. 1972



52415 Ford Transit Custom Bus
Polizei, Verkehrssicherheitsberatung, Bj. 2012



51923 Land Rover Discovery
Wasserschutzpolizei, Bj. 1998



46149 Smart Fortwo
Cyber Polizei, Bj. 2007



50720 Smart Fortwo
Polizei, Bj. 2014



47611 Chevrolet Caprice
NYPD, Auxiliary Police



49002 Ford Crown Victoria
NYPD, Auxiliary Police



50515 Lada 1500
mit Radar, Bj.1973



48117 VW Passat Variant
Bahnpolizei, Bj. 1985



51416 Mercedes G-Klasse 90
Bundesgrenzschutz, Bj.1990



59952 Anhänger
mit Motorboot



51925 Land Rover Discovery
Zoll, Bj. 1998



51911 Land Rover Discovery
Polizei, Bj. 1998



51912
Bundespolizei



51918
Polizei Bayern



51917
Polizei Thüringen



43663 Mercedes-Benz C-Klasse T-Modell
Avantgarde »Polizei-Zivilfahrzeug«, Bj.2007



52414 Ford Transit Custom Bus
Polizei Berlin, Bj. 2012



51144 Mercedes-Benz Vito
Bundespolizei, Bj. 2014



51133
Polizei Bremerhaven



51170 Mercedes-Benz V-Klasse
Autobahnpolizei Berlin, Bj. 2014



52607 Mercedes-Benz Sprinter
Polizei Bayern, Bj. 2018



52606
Polizei Hamburg



48730 Fiat 500
Polizia Italien, Bj. 1965



51916 Land Rover Discovery
Polizia Penitenziaria, Bj. 1998



51148 Mercedes-Benz Vito
Polizia Italien, Bj.2014



51921 Land Rover Discovery
Polis Schweden, Bj. 1998



43917 Volvo 544
Politi Norwegen, Bj. 1958



41712 Pontiac Firebird TransAm
Highway Patrol, Baujahr 1974



46656 Plymouth Fury
Tennessee State Trooper, Bj. 1976



41800 Ford-E350
Sheriff, Bj. 1992



46418 Chevrolet Blazer Facelift
US Postal Police, Bj. 1998



9838961 Chrysler PT Cruiser
School Resource Office Car, Bj. 2000



43604 Mercedes-Benz C-Klasse
Beverly Hills Police, Bj. 2007



46223 Smart Fortwo
Beverly Hills Police, Bj. 2012



46222
Task Force New Orleans



MILITÄR & FLUGZEUGE

Airplanes and military · Avions et véhicules militaires



51509 IFA G5 '60
NVA mit Kran und Grenzpfahl, Bj.1960



51512 IFA G5
NVA, mit Holzkiste, gebrusst



51513 IFA G5 '56
NVA mit Holzpritsche, Bj. 1956



51608 Robur LO 1800 A
NVA Sankra, Bj.1964



51021 Mercedes-Benz Unimog U 5023
Militär, Bj. 2014



51415 Mercedes G-Klasse 90
Feldjäger, Bj. 1990



42753 VW Käfer mit Brezelfenster
Französische Militärregierung, Bj. 1946



80023 Ford V8 G198 TWA
Stabskoffer-LKW JG2 Fliegerabwehr Richthofen



80002 Horch 108 Typ 40
Mannschaftskraftwagen



80081 LKW L 3000 A
mit Ladegut



409 Messerschmitt Me 109
Jubiläumsmodell, Bj. 1939



25011
F4, Britisches Beuteflugzeug



25012
G2, Jagdbomber



25013 Messerschmitt Bf 109
G6, Finnisches Jagdflugzeug mit Markierung vom Luftrennen 1950 (späte Ausführung)



25014
F4/B Deutscher Jagdbomber



25015 Messerschmitt Bf 109
Zahn der Zeit

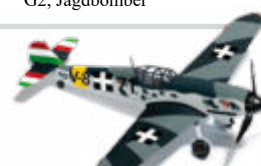

25018
G6, Ungarn



25019 Messerschmitt Bf 109
G, Kroatien



25020
G2, Museum Gatow, Bj. 1939



25021
Geheime Mission



25058
F2, Jagdfliegergalerie Hans Phillip



25059 Messerschmitt Bf 109
F2, Jagdfliegergalerie Adolf Galland, Bj. 1939



25060
G2 Jagdfliegergalerie Günther Rall



25061
G6, Heinz Bartels



25062 Messerschmitt Bf 109
F2, Hans von Hahn



51514 IFA G5 '56
NVA mit Plane, Bj.1956



FORMNEUHEIT
52703 VW 181 Kurierwagen
Oliv, Baujahr 1970





52711 VW 181 Kurierwagen
Feuerwehr Münster, Bj. 1970



52102 UAZ 469
Feuerwehr, Bj. 1972



51928 Land Rover Discovery
Feuerwehr Herne, Bj. 1998



51196 Mercedes-Benz Vito
Feuerwehr Herne Notarzt, Bj. 2014



50719 Smart Fortwo
Feuerwehr Alsfeld, Bj. 2014



51467 Mercedes G-Klasse
Freiwillige Feuerwehr Taufkirchen, Bj. 2008



51258 Framo V901/2 Bus Betriebsfeuerwehr
Gummiwerke Walterhausen, Bj. 1954



52356 KLF
Feuerwehr, Bj. 1957



52103 UAZ 469
Freiwillige Feuerwehr, Bj. 1972



50245 Robur LO 2002 A
Feuerwehr, Bj. 1973



51413 Mercedes G-Klasse 90
Feuerwehr Airport Nürnberg, Bj. 1990



51417
Feuerwehr Dortmund



51418
Feuerwehr Essen



51424
Feuerwehr Geislingen



51425
Feuerwehr München



51426
Feuerwehr Flughafen München



51459 Mercedes G-Klasse
Feuerwehr, Bj. 2008



42225 Mulitcar M26
Feuerwehr mit Schneeräumschild Bj. 1991



54903 STA Anhänger
Freiwillige Feuerwehr



51910 Land Rover Discovery
Bauhjahr 1998



52420 Ford Transit Custom Bus
Feuerwehr, Bj. 2012



51114 Mercedes-Benz Vito
Feuerwehr Halstenbek, Bj. 2014



52210 Mercedes-Benz VF 123 Miesen
Feuerwehr Baiersdorf, Bj. 1977



51432 Mercedes G-Klasse 90
Feuerwehr Baiersdorf, Bj. 1990



52413 Ford Transit Custom Kastenwagen
Feuerwehr Baiersdorf, Bj. 2012



44036 Dodge Power Wagon
Fire Department, Brush1, Bj. 1945



44035 Dodge Power Wagon
Fire Department, Bj. 1945



48238 Chevrolet Pick-up
Firedepartment, Bj. 1950



46018 LaFrance Pumper
Fire Department, Bj. 1968



46030 LaFrance Pumper
Fire Department



46031 LaFrance Leitertrailer
Fire Department, Bj. 1968



46019 LaFrance Leitertrailer
Fire Department, Bj. 1968



46402 Chevrolet Blazer
Fire Chief, Bj. 1998



AMBULANZ & EINSATZFAHRZEUGE

Ambulances and DLRG · Véhicules de secours



52109 UAZ 469
Deutsches Rotes Kreuz, Bj. 1972



52200 Mercedes-Benz VF 123 Miesen
Krankenwagen BRK Nürnberg, Bj. 1977



52201
Krankenwagen der Feuerwehr



52202
Grün



52206
Feuerwehr Dortmund



52208 Mercedes-Benz VF 123 Miesen
Malteser Hamburg, Bj. 1977



52207
Feuerwehr Bonn



51922 Land Rover Discovery
Malteser, Bj. 1998



40705 Mercedes-Benz LP809
DRK, Mobile Sanitätsstation, Bj. 1992



49771 Mercedes-Benz GLK-Klasse
Notarzt Schweiz, Bj. 2009



51135 Mercedes-Benz Vito
Notarzt, Bj. 2014



51142
MTD



43517 Toyota Land Cruiser HZJ 78
Bergwacht Berchtesgaden, Bj. 1985



51919 Land Rover Discovery
Bergwacht Bautzen, Bj. 1998



51117 Mercedes-Benz Vito
Bergrettung Österreich, Bj. 2014



51419 Mercedes G-Klasse 90
Wasserwacht, Bj. 1990



50375 Land Rover Defender
DLRG, Bj. 1983



59951 Anhänger
mit Motorboot, DLRG



49561 Smart Forfour
DLRG, Bj. 2014



51149 Mercedes-Benz Vito
DLRG, Bj. 2014



51927 Land Rover Discovery
Katastrophenschutz Dänemark, Bj. 1998



51924
THW, Weiß



52108 UAZ 469
THW Bayern, Bj. 1972



50565 Lada 1600
THW Landesverband Berlin, Bj. 1976



46870 Mercedes-Benz W123
THW, Bj. 1977



51147 Mercedes-Benz Vito
THW, Silber, Bj. 2014



51124
Blau



51026 Mercedes-Benz Unimog U 5023
THW, Bj. 2014



51027
mit Kran



41840 Ford E-350
Raytown Ambulance, Bj. 1992



51260 Framo V901/2
DRK, Bj. 1954



52204 Mercedes-Benz VF 123 Miesen
ASB, Bj. 1977



51920 Land Rover Discovery
Kinder Notarzt München, Bj. 1998



52205 Mercedes-Benz VF 123 Miesen
Falck, Bj. 1977



52423 Ford Transit Custom Kastenwagen
DLRG, Bj. 2012



51143 Mercedes-Benz Vito
Johanniter, Bj. 2014



FORMNEUHEIT
52810 Ford Ranger
DLRG, Bj. 2016



52710 VW 181 Kurierwagen
DLRG, Bj. 1970



FORD RANGER

Größer, breiter, höher! Am 25. März 2015 wurde dieses Prachtstück auf der International Motor Show in Bangkok vorgestellt. Mit einem umfangreichen Facelift gegenüber dem Vorgängermodell präsentierte Ford diesen Pick-up, der seit Februar 2016 auch in Deutschland erhältlich ist, der Öffentlichkeit. Gerade für Pferdeliebhaber und Zuchtbetriebe ideal, zumal die Gegebenheiten der Wege und Straßen nicht besonders sind und ein geländegängiges Zugfahrzeug voraussetzen. Der Ranger steht interessierten Käufern in verschiedenen Ausstat-

tungslinien zur Verfügung: XL, XLT, Limited und Wildtank. Die Miniatur mit haarscharfer Konturenführung und hochglanzpolierter Karosserie gibt das Vorbild in Perfektion wieder und ist ein willkommenes Sammlerstück für alle Autoliebhaber. Aber auch in der Modellbauszene ist ein solcher Pick-up ein gefundenes Zugfahrzeug für alle Anhänger und somit ein besonderes Glanzstück für alle Szenerien in unwegsamen Geländeformationen.



NEU
FORMNEUHEIT
52801
Rot, Bj. 2016

NEU
FORMNEUHEIT
52803
Blau, Bj. 2016

FORMNEUHEIT
52802
Weiß, Bj. 2016

MIKRO LÄNDER

Exklusiv für Club-Mitglieder:



FORMNEUHEIT
ON THE BEACH, Mikro-Länder, Bj. 2016

BUSCH, FALLER, PREISER und WEINERT Starke Marken bündeln ihre Kräfte und Kompetenzen im MIKRO LÄNDER Club.

Jetzt Mitglied werden!

Profitieren Sie mehrfach von den Vorteilen! Nutzen Sie den direkten Kontakt zu den Herstellern und anderen Modellbauern. Als Mitglied erhalten Sie kostenlos: Hauptkataloge, exklusive Club-Card für z.B. vergünstigte Eintrittspreise bei Messen und Museen, Club-Zeitschrift MIKRO TICKER, exklusive Modelle, Online-Forum, Newsletter mit den neusten Infos u.v.m.



POST- & BUS-FAHRZEUGE

Buses, Postal vehicles cars · Autobus, Véhicules postaux Voitures

42740 VW Käfer mit Brezelfenster, Post, Bj. 1951	40933 DKW 3-6 Deutsche Post, Bj. 1956	51865 Robur Garant K 30 Kombiwagen Deutsche Post, Bj. 1957	51760 Nagetusch DP Zeitungsvertrieb, Bj. 1972
46867 Mercedes-Benz W123 Deutsche Post, Baujahr 1977	48116 VW Passat Variant Telekom Service, Bj. 1985	51429 Mercedes-Benz G-Klasse Deutsche Post, Bj. 1990	
47849 Mercedes-Benz Sprinter DPD, Bj. 1995	47850 Mercedes-Benz Sprinter GLS	52410 Ford Transit Custom Kastenwagen, Bj. 2012	50614 Mercedes-Benz Citan FedEx, Bj. 2013
47851 Mercedes-Benz Sprinter DHL, Bj. 1995	50615 Mercedes-Benz Citan DHL, Bj. 2012	52411 Ford Transit Custom Kastenwagen, DHL, Bj. 2012	
51141 Mercedes-Benz Vito DHL, Bj. 2014	52605 Mercedes-Benz Sprinter DHL, Bj. 2018	47845 Mercedes-Benz Sprinter »Post Schweiz«, Baujahr 1995	
41035 Mercedes-Benz O-3500 Schweizer Postbus, Bj. 1949	41010 Mercedes-Benz O-3500 Unser Heimatland	41009 Mercedes-Benz O-3500 Köhne's Reisedienst	



LIEFERWAGEN, LKW'S & EINSATZFAHRZEUGE

EMS and service vehicles · Véhicules utilitaire



51430 Mercedes-Benz G-Klasse
Flugfeldwagen, Bj. 1990

51431
Follow me



51655 Robur LO 1801 A
Flugfeldwagen, Baujahr 1968



51282 Framo V901/2
Halbbus, Interflug, Bj. 1954



51807 Robur Garant K 30
Kastenwagen, Deutsche Lufthansa



48495 Piaggio Ape 50
Heiße Maroni, Bj. 2006

51758 Nagetusch
Naschwagen, mit Girlanden, Bj. 1972



47740 Ford Modell AA
Deutsche Luft Hansa AG, Bj. 1931



40932 DKW 3=6
Lufthansa, Bj. 1956



51555 IFA G5'56
Benzintankwagen, Deutsche Lufthansa Bj. 1956



50362 Land Rover Defender
Flughafen England, Bj. 1983



51246 Barkas V901/2 Kastenwagen
VEB Barkas-Werke Hainichen, Bj. 1954



51211
Berliner Wasserwerke



51280 Framo V901/2
Halbbus, IFA Blitz Meerane



51281
Kundendienst MZ



51290 VEB Fahrzeug
und Gerätewerk Simson Suhl



51293
KFZ Werk E.Grube Werdau



52300 Framo V901/2
Pritsche, Bj. 1957



52301



52010 Framo V901/2
Kofferverein, Milchwagen Dresden, Bj. 1957



52011
HO



52012
Konsum Gaststättenbetrieb Berlin



52350 Framo V901/2
Pritsche/Plane, Bj. 1957



52351



52352



52355
PGH Marienberg



43918 Volvo 544
Taxi Schweden, Bj. 1958



51810 Robur Garant K 30 Kastenwagen
Leibniz Keks, Bj. 1957



51801



51809
VEB Kreislichtspielbetrieb



51815
VEB Blütenweiß



51808
MZ Renndienst



51806
Schnelldienst, Bj. 1957



51850 Robur Garant K 30 Kombiwagen
Grün, Bj. 1957



51851 Robur Garant K 30 Kombiwagen
Blau, Bj. 1957



51860
Energieversorgung Halle



41909 Citroën HY
metallic, Bj. 1958



41923 Citroën H
Michelin, Bj. 1958



41922 Citroën H
Imkerwagen



51605 Robur LO 1800 A
Messfahrzeug Traktorenwerk Schönebeck, Bj.1964



52104 UAZ 469
LPG Hedersleben, Bj.1972



52416 Ford Transit Custom Bus
Maler, Bj. 2012

NEU



51468 Mercedes-Benz G-Klasse
Tierrettung, Bj. 2008

NEU



50928 Mercedes Unimog U 430
Union Jack, Bj. 2013

NEU



46148 Smart Fortwo Facelift
mit Schneeschieber, Bj. 2007

NEU



48240 Chevrolet Pick-up
Kürbislaster, Bj. 1950

NEU



48496 Piaggio Ape 50
Straßenverkauf, Bj. 2012

NEU



47730 Ford Modell AA
Baujahr 1931



47732



59964 Möbelanhänger
Wilh. Willms



59963 Möbelanhänger
Emil Böttcher



42752 VW Käfer
Eisen Richter, Bj. 1951



40928 DKW 3=6
RWE, Bj. 1956



40929
Varta



40930 DKW 3=6
Praum



40931
Kuhn Kaffee



52400 Ford Transit Custom
Kastenwagen, Bj. 2012



52401



52412 Ford Transit Custom
Kastenwagen, DB, Bj. 2012



52422 Ford Transit Custom
Bus, Bj. 2012



52421



52500 Ford Transit Custom
Hochdach Bus, Bj. 2012



52501



52505



50920 Mercedes-Benz Unimog U 430
mit Seilwinde, Bj. 2013



50925
Colonia



50927
mit Christbaumbeladung



51011 Mercedes-Benz Unimog U 5023
mit Stahlladung, Bj. 2014



51023 Mercedes-Benz Unimog U 5023
mit Ladekran, Bj. 2014



51139 Mercedes-Benz Vito
Schwertransport-Begleitfahrzeug, Bj. 2014



46211 Smart Fortwo Coupé 2012
Lindt, Goldhase (metallic), Bj. 2012



46221
Elektro mit Zapfsäule



50718 Smart Fortwo Coupé 2014
Spedition Dischinger, Bj. 2014



51137 Mercedes-Benz Vito
Tierrettung, Bj. 2014



51138
Kanal-Reinigung



52600 Mercedes-Benz Sprinter
Bj. 2018



52601



52602



LIEFERWAGEN, LKW'S & EINSATZFAHRZEUGE

EMS and service vehicles · Véhicules utilitaire



51570 IFA G5'56 Koffer Saharabeige, Baujahr 1956



51507 IFA G5 '56 ohne Dachluke, Flugzeugwerk Dresden, Grau



51552 IFA G5'60 Tankwagen 1550 Benzintankwagen, Bj. 1960

51553 Benzintankwagen, Minol



51606 Robur LO 1800 A Blaue Post Studioteknik Fernsehen, Bj. 1964



51259 Framo V901/2 Blaue Post Funkentstörungsdienst, Bj. 1954



54904 TSA Anhänger mit Dachgepäckträger & Ersatzrad, Blaue Post Studioteknik Fernsehen



51813 Robur Garant K 30 Kastenwagen, Minol, Bj. 1957

51212 Framo V901/2 Kastenwagen, Minol, Bj. 1954



44933 Pritschenhochlader mit Balkenmäher Straßenmeisterei



44933 mit Rüttelplatte



59942 Anhänger



59958 Anhänger Transport-Anhänger



59954 Transport-Anhänger mit Klappe



51753 Nagetusch Bauwagen, TBK Gera, Bj. 1972



59955 Hunde-Anhänger mit Hund

Klappe zur Selbstmontage.



51759 Nagetusch Mitropa, Bj. 1972



51805 Robur Garant K 30 Kastenwagen, Mitropa, Bj. 1957



42893 Weimar Mobilbagger T 174 - 2 mit Spiralbohrer, Bj. 1974



59943 Anhänger mit Stahl-Gittermasten



46813 Mercedes-Benz W123 T-Modell, ZDF Telemotor, Bj. 1977



50372 Land Rover Defender Bj. 1983



50369 Land Rover Defender Roadsign, Bj.1983



42220 Multicar mit Teerladung, Bj.1991



42213 mit Gitteraufbau



52418 Ford Transit Custom Kastenwagen, Autovermietung Europcar



52419 Autovermietung Sixt



51199 Mercedes-Benz Vito Autovermietung Europcar, Bj. 2014



51197 Autovermietung Sixt



52306 Framo V901/2 Pritsche mit Kran, Bj. 1957



51279 Framo V901/2 Halbbus mit Dachgarten und Kisten, Bj. 1954



51202 Framo V901/2 Kastenwagen, Bj. 1954



52305 Framo V901/2 Pritsche Esso, Bj. 1957



51198 Mercedes-Benz Vito Autovermietung Hertz, Bj. 2014



52417 Ford Transit Custom Kastenwagen Autovermietung Hertz, Bj.2012



AUTOMODELL-BAUSÄTZE

Model car kit · Kits de maquettes de voiture

Basteln was das Zeug hält!!! Jeder kann sich nun sein Auto selbst zusammenbauen und vorher nach Wunsch lackieren, bemalen, mit Decails bekleben und vor dem Zusammenbau auch noch den Innenraum mit Figuren oder sonstigen Dingen ausschmücken.



60252 Mercedes-Benz Sprinter



60254 Robur Garant K 30



60205 Mercedes-Benz G-Klasse



60255 IFA G5 '60



60250 Robur LO 2002 A



60253 Framo V901/2 Kastenwagen



60201 VW Käfer



60256 Citroën H



60200 Lada 1600



60206 Piaggio Ape 50 mit Pritsche



60251 Mercedes-Benz Citan



60257 Ford E-350/Flachdach



60204 Mercedes-Benz E-Klasse T-Modell



60203 Mercedes-Benz Vito



60202 Smart Fortwo 07



RENNFAHRZEUGE

Racing cars · Voitures de course



9838821 Ford RS200 Rallyeversion, Baujahr 1986



42617 Ferrari 250 GTO Start-Nr. 25, Silbermetalllic, Baujahr 1962



50378 Land Rover Defender Camel Trophy 1989, Spanien, Bj. 1983



50373 Land Rover Defender Camel Trophy 1989, Deutschland, Bj. 1983

Lieferung in PC-Box

Lieferung in PC-Box

Lieferung in PC-Box

Lieferung in PC-Box



46900 Auto Union Typ C Megamodel



46906 Auto Union Rennwagen mit Fahrerfigur Bernd Rosemeyer, Bj. 1936



48301 Mercedes-Benz SSKL mit Fahrerfigur Hans Stuck Großer Preis von Deutschland 1931, Bj. 1928



47002 Mercedes-Benz Silberpfeil W196 mit Fahrerfigur Juan Manuel Fangio Großer Preis Schweiz 1954, Bj. 1954



46902 Auto Union Typ C Bergrennwagen, Schatuisland 1937 Hans Stuck, Bj. 1936 Lieferung in PC-Box



TRAKTOREN & LANDWIRTSCHAFT

Tractors · Tracteurs

Zweiseiten-Kipp Anhänger HW 60.11

Der Zweiseiten-Kippanhänger HW 60.11 aus dem Fahrzeugwerk »Ernst Thälmann« in Lübtheen ergänzte den 8t Anhänger HW 80. Idealerweise wurde der Anhänger Traktoren oder LKW als Zugfahrzeug angehängt, um so seinen Einsatzschwerpunkt im Bauwesen und in der Landwirtschaft nachzukommen.

Möglich war auch der Aufbau von Bordwandlerhöhen von 300 mm. Der Anhänger konnte mit Nieder- oder Hochdruckbereifung gefahren werden. Um eine schnellere Ausschüttung

zu gewährleisten, war der Anhänger mit einer motorhydraulischen Kippanlage in Kombination mit einer automatischen Bordwandbetätigung ausgestattet. Diese Anlage konnte vom Zugfahrzeug aus mit Drucköl versorgt/bedient werden. Die Anhängerkupplung war mit mehreren Anschlüssen ausgestattet, so war das Fahren mit zwei Anhängern möglich. Dank seiner einzigartigen Robustheit ist der Anhänger selbst heute noch auf Feldern anzutreffen.



NEU

FORMNEUHEIT

53001 IFA HW 60
ohne Kippgestänge
mit Hochdruckbereifung, Bj. 85



NEU

FORMNEUHEIT

53003 IFA HW 60
mit Kippgestänge
mit Hochdruckbereifung, Bj. 85



NEU

FORMNEUHEIT

53000 IFA HW 60
ohne Kippgestänge
mit Niederdruckbereifung, Bj. 87



NEU

FORMNEUHEIT

53002 IFA HW 60
mit Kippgestänge
mit Niederdruckbereifung, Bj. 87



44930 Anhänger
Heuwagen



42870 Weimar Mobilbagger
T 174 - 2, Gelb, Bj. 1974



42896
T 174 - 2 mit Holzgreifer



51300 Belarus MTS 80
Bj. 1983



51301



51304 Belarus MTS-80
eingebaute Scheinwerfer, Bj. 1990



51305 MTS-82



51307 Belarus MTS-82
Exportversion



42842 Traktor Fortschritt ZT 300-D
Bj. 1967



42843



42844



42847 Traktor Fortschritt ZT 303
Bj. 1967



42848



42849



42855
mit Bäuerin, Blau



42846
mit Schneefräse ASS 02



50420 Traktor Fortschritt ZT 323
mit Bäuerin, Grün, Bj. 1984



50419
mit Schneefräse ASS 02



44922 mit Ballonreifen
mit Ziegelschutt, Bj. 1958



44995 Anhänger
mit Apfelladung



59933 Anhänger
Gartenwagen



40178 Mähdrescher Fortschritt E514
LPG mit Bäuerin, grün, Bj. 1982



50012 Traktor Porsche Junior K
mit Bauer, Bj. 1957



42859 Traktor Fortschritt ZT 300
Fahrschule, Bj. 1967



59946 Anhänger Gummiwagen
Grün, Bj. 1958



59947
Blau



59948
Rot



40071 Traktor Kramer KL 11
mit Bäuerin und Kind, Bj. 1953



40070 Traktor Kramer KL 11
mit Apfelkisten, Bj. 1953



50000 Traktor Porsche Junior K
Bj. 1957



50051 Hofherr-Schranz,
Austro Junior 108, Bj. 1961



50050 Allgaier A 111 L
Bj. 1955



59902 Dreschmaschine
Lanz



59905 Dreschmaschine
Ködel & Böhm, Bj. 1911



59906 Dreschmaschine
kleiner Stiftdrescher, Bj. 1900



59949 Milchanhänger



59965 Anhänger mit Häckselaufbau



59909 Irus Universal Einachser U300 K
mit Bauer, Bj. 1970



59912
mit Aufsitzanhänger



42850 Pflug Fortschritt B200



42851



50082 Bautz Spinne BS4 Heuwender



59913 Anhänger
Feldschmiede, Bj. 1857



59910 Gespann Bulldog
Lanz, Bj. 1921



59903 Slavia 12 HP
Stationärtrieb, Bj. 1920



59904 Deutz TYP MA 511
Stationärtrieb mit Schrotmühle, Bj.1931



59908 Schweröl Motor Bulldog
Lanz, Bj. 1921



59907 Gummi Bulldog
Lanz, Bj. 1921



DRESCHMASCHINEN »LANZ«

Threshers · Batteuses

Die Miniatur ist dem Vorbild aus dem Jahr um 1911 nachempfunden und ist wie sein »großer Bruder«, komplett aus echtem Holz hergestellt. Das detailverliebte Modell hat seitliche Antriebsräder mit (starrten) Antriebsbändern. Beachtenswert ist die spezielle aufgebraute Struktur jedes einzelnen Bretts und der verschiedenen Klappen mit Scharnieren. Wie das Original ist auch am Modell ein ausschwenkbarer Seitenarm angebracht, der die Spreu vom Weizen trennt und weit

entfernt in ein Behältnis bläst. Hauchdünn und super filigran sind auch die Speichenräder - vom Vorbild kaum noch zu unterscheiden. Um diese Perfektion im Modell zu erreichen, sind allerdings bis zu 103 Einzelteile (1:32) notwendig. Davon sind einige so winzig, dass man sich kaum vorstellen kann, was für eine mühevollte Handarbeitskunst dahintersteckt, um daraus dieses vollkommene Sammlerstück zu erschaffen. Eine Kunst und ein ganz besonderes Geschick,

die das Erzgebirge in aller Welt berühmt gemacht haben - Wertarbeit aus Holz »Made in Germany«. Trotz dieser aufwändigen und langen Handarbeitsphase durchlaufen alle Miniaturen nachträglich noch einmal die Qualitätssicherung, damit gewährleistet ist, dass Sie mit diesem originalgetreuen Nachbau ein Markenprodukt in höchster Qualität und Ausführung in Händen halten - ein Sammlerstück der Meisterklasse.



N 8368 Dreschmaschine 1:160

TT 8722 Dreschmaschine 1:120

59902 Dreschmaschine 1:87

ECHT HOLZ!

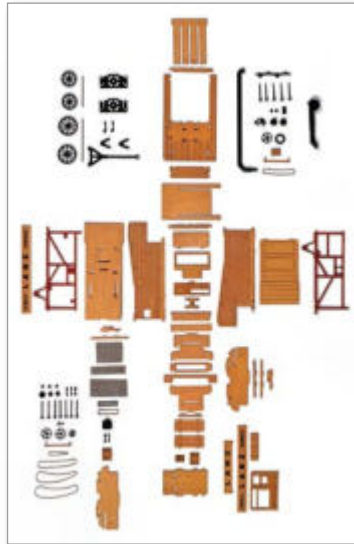

60120 Dreschmaschine 1:32



60100 Dreschmaschine 1:43

MANUFAKTURMODELLE

Factory models · Modèles manufacturés

Diese neue Produktgruppe beinhaltet besondere Modelle aus Industrie und Landwirtschaft, die nur in kleinen Chargen liebevoll in Handarbeit hergestellt werden. Dabei wird auf den bei Busch bewährten Materialmix zugegriffen - sowohl hochwertiger Kunststoffspritzguss, ausgeklügelter Lasercut und/oder raffinierter 3D-Druck. Drei unterschiedliche Fertigungstechniken, in denen atemberaubende Miniaturen der Extraklasse entstehen. Ein kreatives Team

in Konstruktion und Vermessungstechnik sowie in der Fertigung und Montage gibt alles, um detailgetreue und hochwertige Modelle präsentieren zu können.



Maßstab 1:43

Maßstab 1:87



59995 Fortschritt K 142

Stiften-Schmal Dreschmaschine mit Strohzerreißer



60103 Traktor Fordson Model F

AUTOMODELLE 1:43



60001 Piaggio Ape 50 mit Pritsche, Bj. 2006

60002 Piaggio Ape 50 mit Pritsche

60003 Piaggio Ape 50 mit Pritsche



60004 Piaggio Ape 50 mit Milchkannen. Ladefläche aus Echtholz.



60058 Piaggio Ape 50 Cross Country, Bj. 2006



60051 Piaggio Ape 50 mit Kastenaufbau, Bj. 2006

60052 Rot



60053 Piaggio Ape 50 mit Kastenaufbau, T H W





94101
94100 Goliath Express 1100
Kombi, Bj. 1957

94102



94126
Mehrzweckfahrzeug T H W

94124
Krankenwagen



94170 Goliath Express 1100
Luxusbus Edition Goliath Werk, Bj. 1957

94152



94150



94001
94000 Goliath Express 1100
Kastenwagen, Baujahr 1957

94002



94035
Deutsche Bundespost



94036
Fernmeldedienst



94021 mit Dachgepäckträger
Kundendienst



94020
Edition Goliath Werk



94201
94200 Goliath Express 1100
Pritschenwagen, Bj. 1957

94202



94221 Goliath Express 1100
Pritschenwagen Edition Goliath Werk, Bj. 1957

94210



94211

OXFORD



Modellautos des englischen Herstellers »Oxford Diecast« begeistern Sammler unterschiedlichster Fahrzeugepochen und Maßstäbe. Dazu gehören auch HO-Fahrzeuge im Maßstab 1:87 in Metall-Ausführung. Die Modelle werden in transparenten Displayboxen präsentiert und in attraktiven Kartonfaltschachteln mit Sichtfenster geliefert.



201 133525
Mercury
Bj. 1949, Jubiläums-Set mit 3 Modellen

201 129382
Chrysler 300 Convertible
Bj. 1961

201 129443
Dodge Charger
Bj. 1968

201 129436

201 133419

201 130753
Chevrolet Stepside Pick Up
Bj. 1965

201 129474



201 128606
Oldsmobile Rocket 88 Coupé
Bj. 1950

201 129511
Pontiac Chieftain 4-Türer
Bj. 1954

201 133495

201 116085
Lincoln Continental MkII
Bj. 1956

201 113961

201 133365
Chevrolet Impala Cabrio
Bj. 1961

201 133389
Chevrolet Nomad
Bj. 1957

201 129399
Cadillac Eldorado
Bj. 1957

201 133457
DeSoto Suburban
Bj. 1946



201 129481
Dodge D100 Sweptside Pick Up
Bj. 1957

201 133440

201 133426
Dodge Charger Daytona
Bj. 1969

201 129467

201 133341
Cadillac Eldorado
Baujahr 1957

201 133488
Pontiac Bonneville Coupé
Bj. 1959

201 129405
Chevrolet Corvair Coupé
Bj. 1963

201 133358

201 133396
Cadillac Sedan Deville
Bj. 1961



94022 Goliath Express 1100
Kastenwagen, DRK Bonn Blutspendedienst Bj. 1957

NEU



94219 Goliath Express 1100 Pritschenwagen
Fernmeldedienst, Bj. 1957

NEU



94218 Goliath Express 1100 Pritschenwagen
Deutsche Bundespost, Bj. 1957

NEU



94121 Goliath Express 1100
Luxusbus Schustetter Betten Rosenheim, Bj. 1957

NEU



94010 Goliath Express 1100
Kastenwagen ,Wrede Papiergroßhandlung, Bj. 1957

NEU

Seit 1961 wurden in Annaberg-Buchholz liebevoll gestaltete, maßstabsgetreue Miniaturen gefertigt, die auf dem Stand der damaligen Zeit waren und keinen Vergleich scheuen mussten. Leider wurde die Marke in den 70er Jahren umbenannt. Die Modellautoproduktion fand von nun an in Berlin unter wechselnden Marken statt. Nur knapp 50 km vom damaligen Produktionsstandort Annaberg-Buchholz entfernt werden seit 2012 die neuen ESPEWE-Modelle im Produktionswerk der Firma Busch in Schönheide hergestellt und tragen den Zusatz »Made in Germany«. Damit trifft zeitgemäße Fertigungstechnik auf Tradition. Und selbstverständlich stehen neben neu entwickelten Modellfahrzeugen nach ostdeutschen Vorbildern, wie W50 und L60 nun auch Modelle der ersten Produktionszeit der 60er Jahre im Mittelpunkt des Sortiments und der zukünftigen Entwicklungen.



NEU
95614 IFA S4000 TLF
BVB, Bj. 1965



NEU
95615 IFA S4000 TLF
Bauchbinde, Bj. 1965



NEU
95724 Robur LO 2500
Betriebsferienheim Eisenberg, Bj. 1961



95135 IFA W50 L LF Schankwagen
Butchersbar, in Präsentbox



95708 Robur LO 2500
Bj. 1961



95709 Robur LO 2500
Freizeit-Reisen, Bj. 1961



95711 Robur LO 2500
Bj. 1961



95715
NVA

95716 Robur LO 2500
Radeberger, Bj. 1961



95717 Robur LO 2500
Orange



95718 Robur LO 2500
Grün/Weiß



95719 Robur LO 2500
Blau



95720 Robur LO 2500
BVG Berlin, Blau



95721 Robur LO 2500
»Seemöwe«, Weiß, Bj. 1961



95722 Robur LO 2500
DVB Dresden, Beige, Bj. 1961



95606 IFA S4000 TLF
Zirkus Busch, Bj. 1965



95608 IFA S4000 TLF
Straßenmeisterei



95901 W50L Zubehör-Set
Hochdruckbereifung



95602 IFA S4000 TLF
Feuerwehr, Bj. 1965



95603 IFA S4000 TLF
Vorbildliche Freiwillige Feuerwehr



95604 IFA S4000 TLF
Feuerwehr mit Bauchbinde



95900 W50L Zubehör-Set
Niederdruckbereifung



95902 W50L Zubehör-Set
Fahrgestell/Spoiler



95610 IFA S4000 TLF Vorbildliche
Freiwillige Feuerwehr, Buschheide



95616 IFA S4000 TLF
Feuerwehr mit Bauchbinde und RKL



95613 IFA S4000 TLF
Werkstattwagen Roter Oktober



95612 IFA S4000 TLF
Werkstattwagen, Orange



95136 IFA W50 MK
Lacufa, Bj. 1985



95175 IFA W50 MK
IFA Service Instruction, Bj. 1985



95174 IFA W50 MK
Möbelspedition, Bj. 1985



95146 IFA W50 MK
Volan, Bj. 1985



95148 IFA W50 MK
Zirkus Berolina



95176 IFA W50 FP
Versuchslackierung, Bj. 1984



95120 IFA W50 SP
CSAD



95133 IFA W50 SP
Handelstransport



95162 IFA W50 SP
IFA Kombinat, Bj. 1973



95163 IFA W50 SP
Versorgungstransporte ABT, Bj. 1973



95154 IFA W50L FP
IFA Fahrschule, Bj. 1973



95262 IFA W50 mit Koffer
Roter Oktober, Bj. 1973



95251 IFA W50 Zugmaschine
Schausteller, Bj. 1968



95256 IFA W50 LA/PV
GST, Motorsport, Bj. 1969



95250 IFA W50 mit Tank
LPG, Bj. 1976



95031 HW 80 HTS Tankaufbau
LPG, Bj. 1984



95252 IFA W50 LA/PV
Messe, Safari, Baujahr 1973



95215 IFA W50 LA/A
Ägypten



95220 IFA W50 LA/A
Ägypten



95520 IFA L60 ETK
Ägypten



95542 IFA L60 ETK
Irak, gealtert, Bj. 1987



95546 IFA L60 ETK
Irak, Beutefahrzeug, Bj. 1987



95255 IFA W50 LA Expedition
Mexiko, Beige, Bj. 1968



95178 IFA W50 SP
Hungarocamion, Bretterboden, Bj. 1984



95544 IFA L60 DSK
Irak, gealtert, Bj. 1987



95179 IFA W50 BTP
Messe IFA Logo, Bj. 1984



95034 HW 80.11
SHA Conow, Bj. 1984



95531 IFA L60 ETK
Fortschritt, Bj. 1987



95237 IFA W50 PV
BBG Eberswalde mit Schneepflug



95543 IFA L60 3SK
mit Schneepflug BVB, Bj. 1987



95538 IFA L60 SHA
Bj. 1987



95547 IFA L60 2SK



95540 IFA L60 3SK



95506 IFA L60 3SK
THW Cottbus



95533 IFA L60 3SK
mit LSR, Autobahnmeisterei Dessau



95258 IFA W50 3SK mit erhöhter
Bordwand Roter Oktober, Bj. 1973



95261 IFA W50 mit Tank
Roter Oktober, Bj. 1973



95027 HW 80 HTS
Goldene Ähre



95033
Conow

95032 HW 80.11
Ernst Grube, Bj. 1984



95243 IFA W50 mit Tank
Präsidium Hilfszug, DRK, Bj. 1973



95247 IFA W50 mit Koffer
Präsidium Hilfszug, DRK, Bj. 1973



95234 IFA W50 LA/A
Seenotrettung



95245 IFA W50 TLF mit Pritsche
Seenotrettung, Bj. 1969



95512 IFA L60 3SK
NVA, Bj. 1987



95161 IFA W50 RTGW
Vorbildliche Freiwillige Feuerwehr



95249 IFA W50 LA/PV
Feuerwehr mit Plane, Bj. 1973



95121 IFA W50 TLF
Tschechische Feuerwehr



95242 IFA W50 TLF GMK mit
Bauchbinde (offene Jalousie), Bj. 1985



95253 IFA W50 TLF GMK
Berlin Weißensee



95257 IFA W50 TLF
Messe (IFA-Logo), Bj. 1984



95180 IFA W50 LF
Messe (IFA-Logo), Bj. 1984





49953 Zubehör-Set
»Landwirtschaft«



49966 Umbau-Set zur Gestaltung eines Monster-Trucks



1690 Modellbau-Reiniger
Sagen Sie dem Staub den Kampf an!

Cyber-Clean® Modellbau-Reiniger entfernt Schmutz und Staub und eliminiert sogar 99,999% der Keime, ohne dabei Rückstände zu hinterlassen. Selbst kleine Zwischenräume, Fugen, Schlitzlöcher und unebene Oberflächen sind für die Schmutz absorbierende High-Tech-Reinigungsmasse kein Problem. Schluss mit fuselnden Staubtüchern und unangenehm riechenden Putzlapen. Cyber-Clean® ist der ideale Reiniger für Modelle und Sammlerobjekte jeglicher Art. Reinigen Sie Ihre Schätze auf die sanfte Weise.



49961 Zubehör-Set I für moderne amerikanische Einsatzfahrzeuge. Signalbalken, V-Balken usw. für die Ausrüstung moderner amerikanischer Einsatzfahrzeuge.

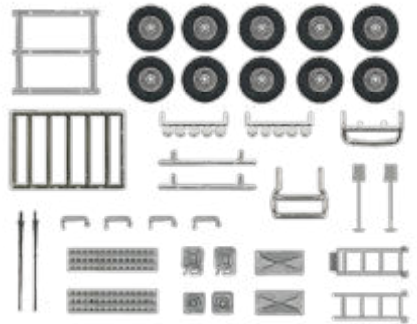

49952 Zubehör Set »Offroad«



49959 Zubehör-Set
»Edle Speichenfelgen«

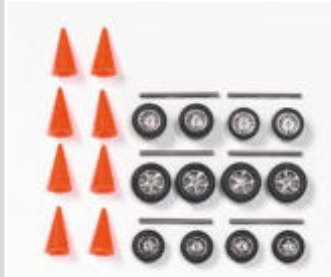

49956 Zubehör-Set
»Rennsport«



49955 Zubehör-Set
»Robur«



49958 Zubehör-Set
»Feuerwehr-Reifen-Set«



49962 Zubehör-Set für ältere amerikanische Einsatzfahrzeuge. Signalbalken, Signalhörner und andere Zurüstteile für amerikanische Einsatzfahrzeuge der 50er Jahre.



49963 Zubehör-Set II für moderne amerikanische Einsatzfahrzeuge. Zwei verschiedene Signalbalken, Suchscheinwerfer und Zubehör.



49968 Holiday-Set
Ausgestaltungs-Set für Automodelle rund um das Thema »Urlaub« inklusive verschiedener Anhängerkupplungen.

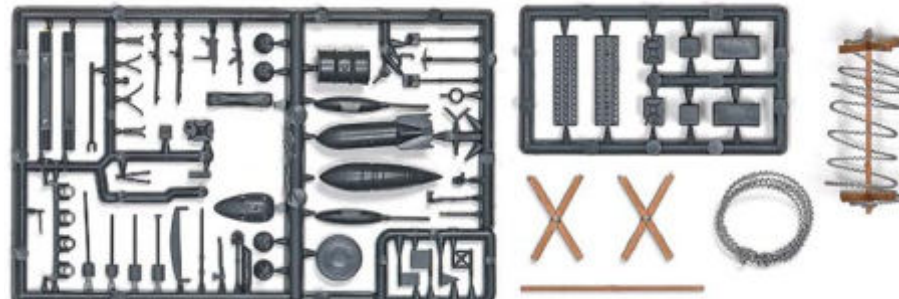

49957 Zubehör-Set
»Militär«



49974 Zubehör-Set
»Niederdruckbereifung«



49950 Sportfelgen mit Reifen. 3 verschiedene Sportfelgen mit Reifen und Achsen für die Umrüstung von 3 PKWs. Außerdem 2 Spoiler.



49951 Felgen mit Weißwandreifen. 3 verschiedene Felgentypen mit Weißwandreifen und Achsen für die Umrüstung von 3 PKWs.

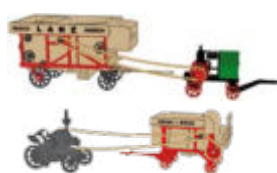

49975 Set
Antriebsriemen



49970 Kunststoffbox
Größe 76 x 30 x 34mm



49971 »Smart«-Tower-Box
Größe 51 x 25 x 25mm



49973 Präsentationsbox
Größe 89 x 46 x 53mm



49972 Präsentationsbox
Größe 103 x 57 x 61mm

Best.-Nr. 49993



4 001738 499933

Busch GmbH & Co. KG
Heidelberger Straße 26
D-68519 Viernheim
info@busch-model.com
www.busch-model.com



Ihr Fachgeschäft: